

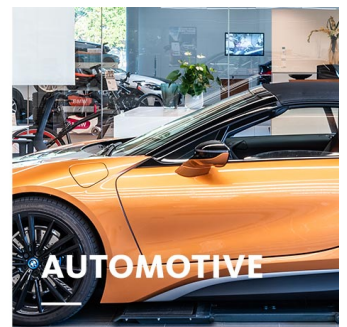

NIMBUS VARIO PLUS

RECESSED LUMINAIRE

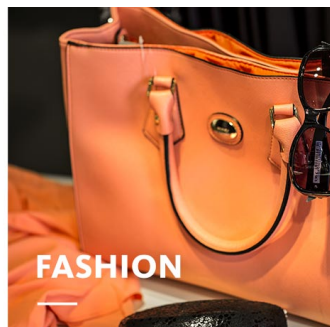





High luminous flux with homogeneous light distribution and light incidence flush with the ceiling: NIMBUS VARIO PLUS efficiently illuminates the target surface. This wallwasher can be flexibly adjusted to match the individual ceiling height and merchandise presentation.



NIMBUS VARIO PLUS

oktalite

www.oktalite.com/nimbus-vario-plus-r

Type of luminaire	recessed luminaire
Application areas	Wide-area merchandise illumination
Pan/tilt range	9 lockable levels, can be swivelled to 45°
Mounting	spring mounting
Ceiling thickness	1 - 25 mm
Lighting technology	LED ^{IQ} DALI
LED Luminous Flux Class	3000 lm - 4000 lm
Light colour White	2700 K, 3000 K, 3000 K - Efficient White, 3000 K - Brilliant Colour, 3500 K, 4000 K
Light colour Food*	M, M+F, BF
Cooling	passive
Supply unit	DALI driver separate
Luminaire colour	RAL 9005 jet black RAL 9006 white aluminium RAL 9016 traffic white Special colours on request
Surface	structure powder-coated
Nominal voltage	220 - 240 V, 50/60Hz
Lighting controls	DALI DT6
Installation	Recommended for new installation.
Weight	Approx. 1.8 kg
Components	 Luminaire housing  Supply unit
Test seal	    

* M = Meat,
M = Meat, F = Fish,
BF = Brilliant Food

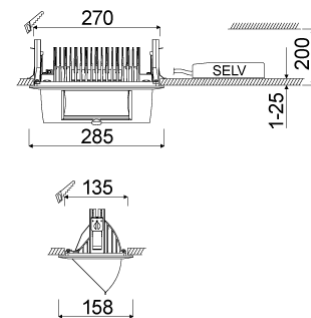

Technical details as well as weight specifications and measurements have been prepared with care. Errors excepted. All dimensions in mm · LED service life data: L80/B10 at ambient temperature (ta) 25°C. Rated lamp service life 50,000h. Luminous flux and efficiency specifications are subject to a tolerance of +/- 10%. Min CRI Ra: >80 / >90 · Product images are used as an example and may differ from the original · We reserve the right to make changes, insofar as they serve progress. Oktalite Lichttechnik GmbH · Mathias-Brüggen-Str. 73 · 50829 Cologne · T +49 221 59767-0 · F +49 221 59767-40 · mail@oktalite.com · www.oktalite.com · 2021-01-24



NIMBUS VARIO PLUS

oktalite

LED Luminous Flux Class	Light colour	CRI R _a	system luminous flux	System performance	Order number		
					white	silver	black
4000 lm	2700 K	81	3750 lm	28 W	10187862	10187863	10187864
	3000 K	83	3855 lm	28 W	10187865	10187866	10187867
	3000 K - Efficient White	94	3930 lm	34 W	10187868	10187869	10187870
	3000 K - Brilliant Colour	97	3925 lm	46 W	10187877	10187878	10187879
	3500 K	85	3930 lm	28 W	10187871	10187872	10187873
	4000 K	83	4060 lm	28 W	10187874	10187875	10187876
3000 lm	M	-	2860 lm	46 W	10187853	10187854	10187855
	M+F	-	2665 lm	46 W	10187856	10187857	10187858
4000 lm	BF	-	3615 lm	40 W	10213477	10213478	10213479

Efficient White: R₉ = 75, R_f = 91, R_g = 102Brilliant Colour: R₉ = 94, R_f = 95, R_g = 104

Technical details as well as weight specifications and measurements have been prepared with care. Errors excepted. All dimensions in mm · LED service life data: L80/B10 at ambient temperature (ta) 25°C. Rated lamp service life 50,000h. Luminous flux and efficiency specifications are subject to a tolerance of +/- 10%. Min CRI Ra: >80 / >90 · Product images are used as an example and may differ from the original · We reserve the right to make changes, insofar as they serve progress. Oktalite Lichttechnik GmbH · Mathias-Brüggen-Str. 73 · 50829 Cologne · T +49 221 59767-0 · F +49 221 59767-40 · mail@oktalite.com · www.oktalite.com · 2021-01-24



Optic - LED^{IQ} DALI

Optic NIMBUS - LED^{IQ} DALI

oktalite

Optic folding reflector
Type Optic integrated

Beam angle	Cover	LOR
Wall Washer	without	91 %

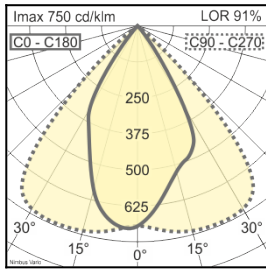

Technical details as well as weight specifications and measurements have been prepared with care. Errors excepted. All dimensions in mm · LED service life data: L80/B10 at ambient temperature (ta) 25°C. Rated lamp service life 50,000h. Luminous flux and efficiency specifications are subject to a tolerance of +/- 10%. Min CRI Ra: >80 / >90 · Product images are used as an example and may differ from the original · We reserve the right to make changes, insofar as they serve progress. Oktalite Lichttechnik GmbH · Mathias-Brüggen-Str. 73 · 50829 Cologne · T +49 221 59767-0 · F +49 221 59767-40 · mail@oktalite.com · www.oktalite.com · 2021-01-24



Supply unit - LED^{IQ} DALI

DALI driver

oktalite

Connection type	Pre-wired plug-in connectivity
Mains connection	GST 18i3
Cable length secondary	400 mm
Nominal voltage	220 - 240 V, 50/60Hz
protection	IP20
protection class	I, II
Lighting controls	DALI DT6
Lighting technology	LED ^{IQ} DALI

Lighting technology	Luminaire connection	Output	System performance	max. luminaires B16	Order number
LED IQ DALI	RNV	750 mA	28 W	50	10185635
LED IQ DALI	RNV	900 mA	34 W	50	10185638
LED IQ DALI	RNV	1050 mA	40 W	50	10185642
LED IQ DALI	RNV	1200 mA	46 W	20	10185643

Technical details as well as weight specifications and measurements have been prepared with care. Errors excepted. All dimensions in mm · LED service life data: L80/B10 at ambient temperature (ta) 25°C. Rated lamp service life 50,000h. Luminous flux and efficiency specifications are subject to a tolerance of +/- 10%. Min CRI Ra: >80 / >90 · Product images are used as an example and may differ from the original · We reserve the right to make changes, insofar as they serve progress. Oktalite Lichttechnik GmbH · Mathias-Brüggen-Str. 73 · 50829 Cologne · T +49 221 59767-0 · F +49 221 59767-40 · mail@oktalite.com · www.oktalite.com · 2021-01-24