

3-CIRCUIT TRACKS

oktalite





Luminaire Type
 Mounting
 Length
 Colour
 Connection

3-ph system global
 Surface-mounted / recessed / pendant
 1000 mm, 2000 mm, 3000 mm
 white, silver / grey, black
 AC current 230 V = max. 3600 W (16 A)
 three-circuit current 400 V = max. 3 x 3600 W
 = 10.800 W with individual fusing of all 3 circuits (3 x 16 A)



Surface
 Light control
 Components

Aluminium
 on request

-  3-circuit track
-  Feeding
-  Coupler
-  Mounting
-  Accessories

Test seal

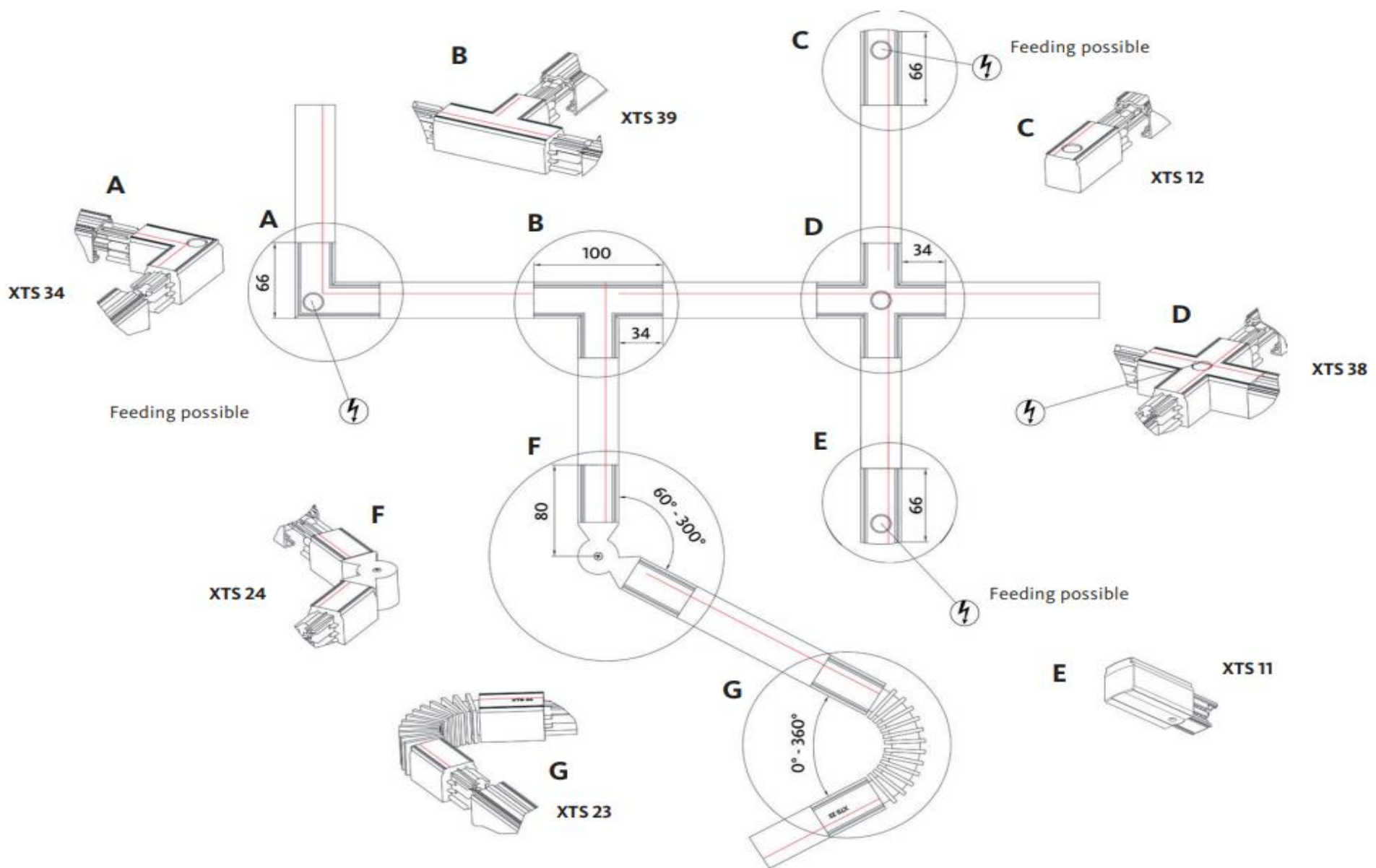

Technical details as well as weight specifications and measurements have been prepared with care. Errors excepted.
 All dimensions in mm · Product images are used as an example and may differ from the original · We reserve the right to make changes, insofar as they serve progress · Oktalite Lichttechnik GmbH · Mathias-Brüggen-Str. 73 · 50829 Cologne · T +49 221 59767-0 · F +49 221 59767-40 · mail@oktalite.com · www.oktalite.com – 08.06.2022



3-CIRCUIT TRACKS

oktalite

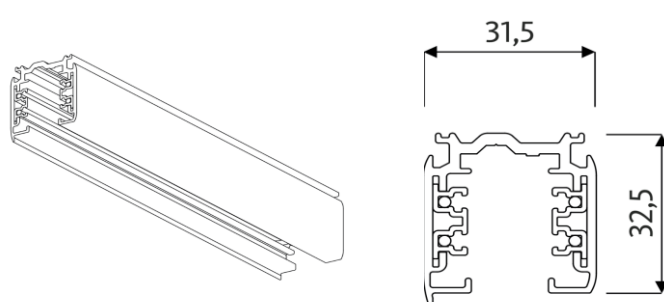
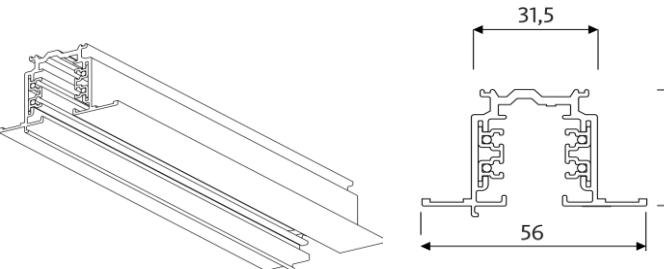
Tracks	Length	Reference number			
		white	silver	black	
Surface-mounted track 	1000 mm	10062337 5851200	10062343 5851800	10062340 5851500	
	2000 mm	10062338 5851300	10062344 5851900	10062341 5851600	
	3000 mm	10062339 5851400	10062345 5852000	10062342 5851700	
	Recessed track 	1000 mm	10085505 7942200	10085506 7942300	10077996 7942400
		2000 mm	10062348 5852300	10062353 5852800	10062350 5852500
		3000 mm	10062349 5852400	10062354 5852900	10062351 5852600

Electric feeding

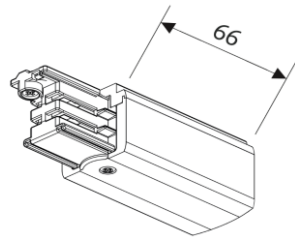

Electric feeding, XTS 12

10062373 5854800	10089971 5857200	10062385 5856000
---------------------	---------------------	---------------------

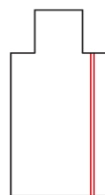
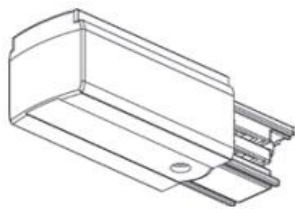



Electric feeding, XTS 11

10062372 5854700	10089970 5857100	10062384 5855900
---------------------	---------------------	---------------------

All dimensions in mm

3-CIRCUIT TRACKS

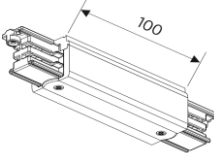
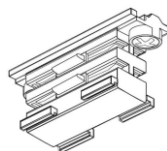
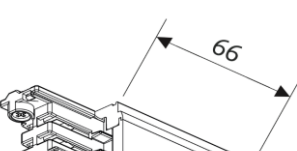
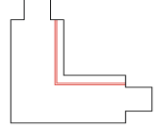
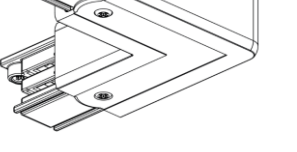
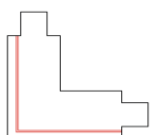
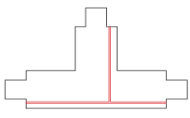
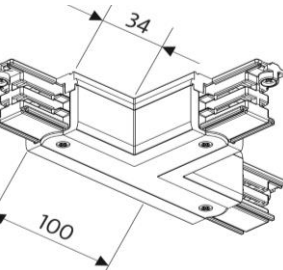
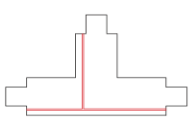
oktalite

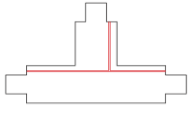
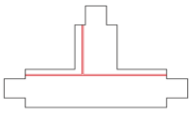
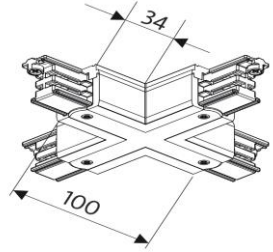
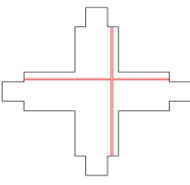
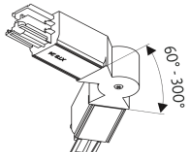
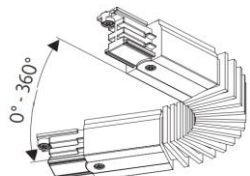



Coupler	Reference number	white	silver	black
	Coupler with feeding possible, XTS 14	10062881 5974200	10089982 5974300	10064283 7942500
	Coupler without feeding, XTS 21	10062882 5973500	10089972 5973600	10064282 7942600
	L-connector, XTS 34	10062378 5855300	10089975 5857600	10062390 5856500
				
	L-connector, XTS 35	10062377 5855200	10089974 5857500	10062389 5856400
				
	T-connector, XTS 36	10108274 7942700	10089976 5857700	10062391 5856600
	T-connector, XTS 39	10062382 5855700	10089979 5858000	10062394 5856900
				
	T-connector, XTS 40	10062383 5855800	10089980 5855500	10062395 5857000
				
	T-connector, XTS 37	10062380 5858100	10089977 5857800	10062392 5856700
	X-connector, XTS 38	10062376 5855100	10089973 5857400	10109039 7942800
				
	Articulated coupler, XTS 24	10062374 5854900	10062398 5857300	10062386 5856100
	flexible coupler, XTS 23	10062375 5855000	10107715 7942900	10062387 5856200

All dimensions in mm

Technical details as well as weight specifications and measurements have been prepared with care. Errors excepted.
 All dimensions in mm · Product images are used as an example and may differ from the original · We reserve the right to make changes, insofar as they serve progress · Oktalite Lichttechnik GmbH · Mathias-Brüggen-Str. 73 ·
 50829 Cologne · T +49 221 59767-0 · F +49 221 59767-40 · mail@oktalite.com · www.oktalite.com – 08.06.2022

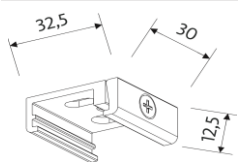
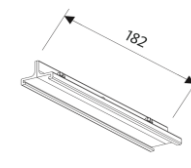
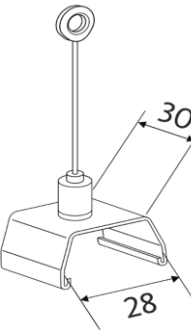
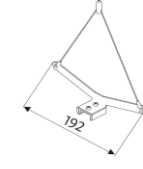
3-CIRCUIT TRACKS

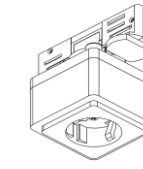
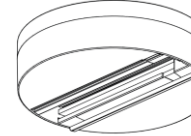
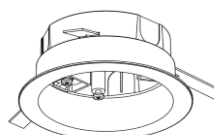
oktalite

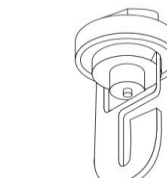
Mountings	Reference number			
		white	silver	black
	Ceiling ring clamp	10062356 5853100	10062368 5854300	10062361 5853600
	Joint connector for pendant mounting	10062355 5853000	10062367 5854200	10062360 5853500
	Wire suspension set 1500 mm chrome	-	10216712 7943000	-
	Wire suspension set 3000 mm chrome	-	10216713 7943100	-
	Wire suspension set 6000 mm chrome	-	10216714 7943200	-
	Track stabiliser	-	10073068 5974000	-
	Ceiling fixing for wire suspension	-	10064095 5973900	-
	Adapter with socket	10172942 7959700	-	10062408 5858300
	3-circuit surface-mounted point outlet	10062409 5858400	10062413 5858800	10062411 5858600
	Recessing box for 3-circuit surface-mounted point outlet	10113755 7943300	10111673 7943400	10062412 5858700
	Plate for universal hook	10172944 7943500	-	10064317 7943600
	Universal hook	10172943 7943700	-	10064316 7943800

All dimensions in mm

Technical details as well as weight specifications and measurements have been prepared with care. Errors excepted.
 All dimensions in mm · Product images are used as an example and may differ from the original · We reserve the right to make changes, insofar as they serve progress · Oktalite Lichttechnik GmbH · Mathias-Brüggen-Str. 73 · 50829 Cologne · T +49 221 59767-0 · F +49 221 59767-40 · mail@oktalite.com · www.oktalite.com – 08.06.2022

3-CIRCUIT TRACKS

oktalite

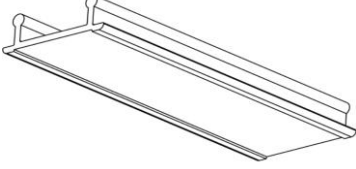
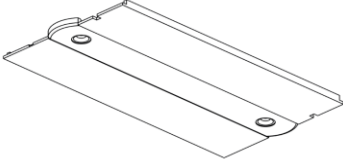
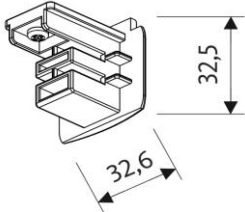
Covers	Reference number	white	silver	black
	Cover for surface-mounted track	10062419 5859400	-	10062420 5859500
	Cover for feeding / recessed track	10103816 7943900	10118243 7944000	10118244 7944100
	End plate	10062381 5855600	10089978 5857900	10062393 5856800

Accessories

	Bending tool	-	10062418 5859300	-
---	--------------	---	---------------------	---

All dimensions in mm

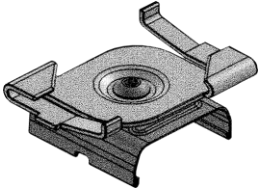
Track clips for grid ceilings	Bestellnummer	weiß	silber	schwarz
	Track clip with spring clip	50181291 8119100	50272756 8119500	50177074 8119000
	Packaging unit 5 pieces	-	50272759 8119600	50249377 8119400
	Packaging unit 10 pieces	-	50272761 8119700	50249376 8119300
	Packaging unit 100 pieces	-	50272762 8119800	50249337 8119200

Mounting instruction

Please note the mounting instructions on the data sheets from the manufacturer Nordic Aluminum.

Technical details as well as weight specifications and measurements have been prepared with care. Errors excepted.
 All dimensions in mm · Product images are used as an example and may differ from the original · We reserve the right to make changes, insofar as they serve progress · Oktalite Lichttechnik GmbH · Mathias-Brüggen-Str. 73 ·
 50829 Cologne · T +49 221 59767-0 · F +49 221 59767-40 · mail@oktalite.com · www.oktalite.com – 12.04.2023